

# BIOLOGY

## Chapter 6: Molecular Basis of Inheritance



## Molecular Basis of Inheritance

### The DNA:

DNA (Deoxyribonucleic Acid) and RNA (Ribonucleic Acid) are two types of nucleic acid found in living organisms. DNA acts as genetic material in most of the organisms. RNA also acts as genetic material in some organisms as in some viruses and acts as messenger. It functions as adapter, structural, and in some cases as a catalytic molecule.

The DNA it is a long polymer of deoxyribonucleotides. A pair of nucleotides is also known as base pairs. Length of DNA is usually defined as number of nucleotides present in it. Escherichia coli have  $4.6 \times 10^6$  bp and haploid content of human DNA is  $3.3 \times 10^9$  bp.

### Structure of Polynucleotide Chain:

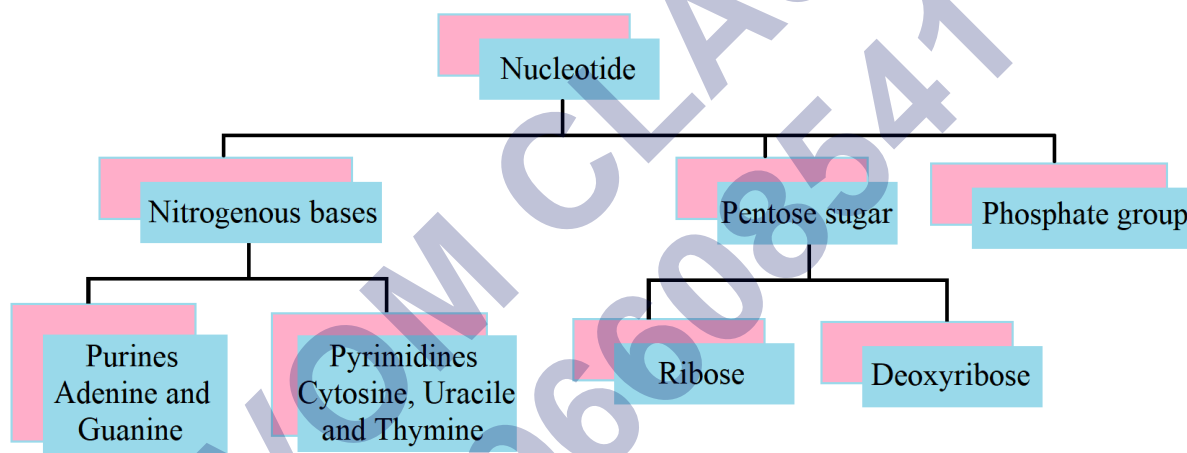

A nucleotide has three components – a nitrogenous base, a pentose sugar (ribose in case of RNA, and deoxyribose for DNA), and a phosphate group. There are two types of nitrogenous bases – Purines (Adenine and Guanine), and Pyrimidines (Cytosine, Uracil and Thymine). Cytosine is common for both DNA and RNA and Thymine is present in DNA. Uracil is present in RNA at the place of Thymine.

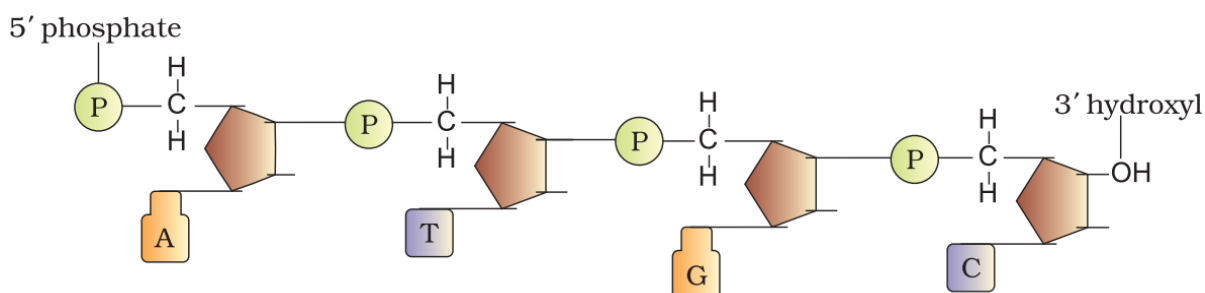

### A polynucleotide chain:

A nitrogenous base is linked to pentose sugar with N-glycosidic linkage to form to form a

nucleoside. When phosphate group is linked 5'-OH of a nucleoside through phosphoester linkage nucleotide is formed. Two nucleotides are linked through 3'-5' phosphodiester linkage to form dinucleotide. More nucleotide joins together to form polynucleotide. In RNA, nucleotide residue has additional -OH group present at 2'-position in ribose and uracil is found at the place of Thymine.

## DNA & RNA

### Structure differences:

DNA	RNA
The sugar present in DNA is 2-deoxy-D-(-)-ribose.	The sugar present in RNA is D-(-)-ribose.
DNA contains cytosine and thymine as pyrimidine bases and guanine and adenine as purine bases.	RNA contains cytosine and uracil as pyrimidine bases and guanine and adenine as purine bases.
DNA has double strand $\alpha$ -helix structure.	RNA has a single stranded $\alpha$ -helix structure.
DNA molecules are very large their molecular mass may vary from $6 \times 10^6$ – $16 \times 10^6$ u	RNA molecules are comparatively much smaller with molecular mass ranging from 20,000 – 40,000.

### Functional differences:

**DNA:** DNA has unique property of replication. DNA controls the transmission of hereditary effects.

**RNA:** RNA usually does not replicate. RNA controls the synthesis of proteins.

### DNA double helix:

In 1953 that James Watson and Francis Crick, based on the X-ray diffraction data produced by Maurice Wilkins and Rosalind Franklin, proposed a very simple but famous Double Helix model for the structure of DNA, the ratios between Adenine and Thymine and Guanine and Cytosine are constant and equals one. The base pairing confers a very unique property to the polynucleotide chains. They are said to be complementary to each other, each strand from a DNA act as a template for synthesis of a new strand, the two double stranded DNA produced would be identical to the parental DNA molecule.

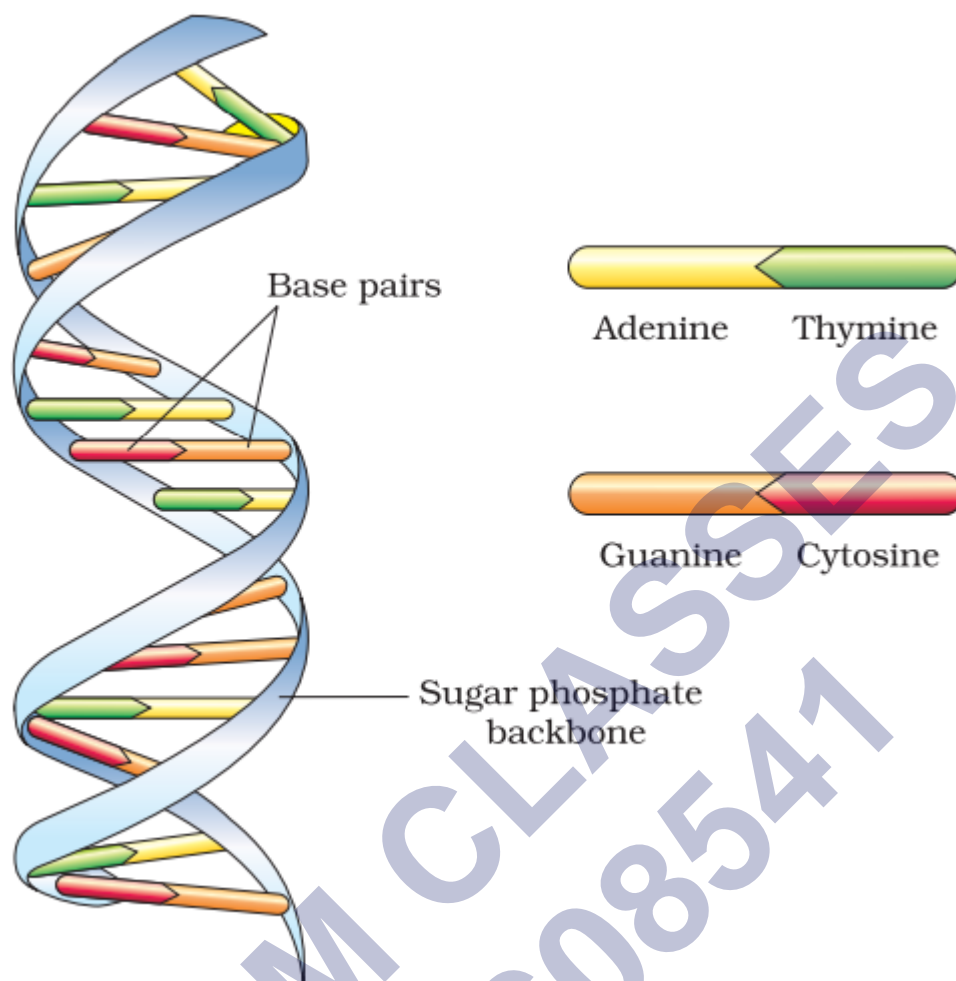

**The silent features of this model are:**

- DNA is made of two polynucleotide chains in which backbone is made up of sugar-phosphate and bases projected inside it.
- Two chains have anti-parallel polarity. One  $5' \rightarrow 3'$  and with  $3' \rightarrow 5'$ .
- The bases in two strands are paired through H-bonds. Adenine and Thymine forms double hydrogen bond and Guanine and Cytosine forms triple hydrogen bonds.
- Two chains are coiled in right handed fashion. The pitch of helix is 3.4 nm and roughly 10 bp in each turn.
- The plane of one base pair stacks over the other in double helix to confer stability.

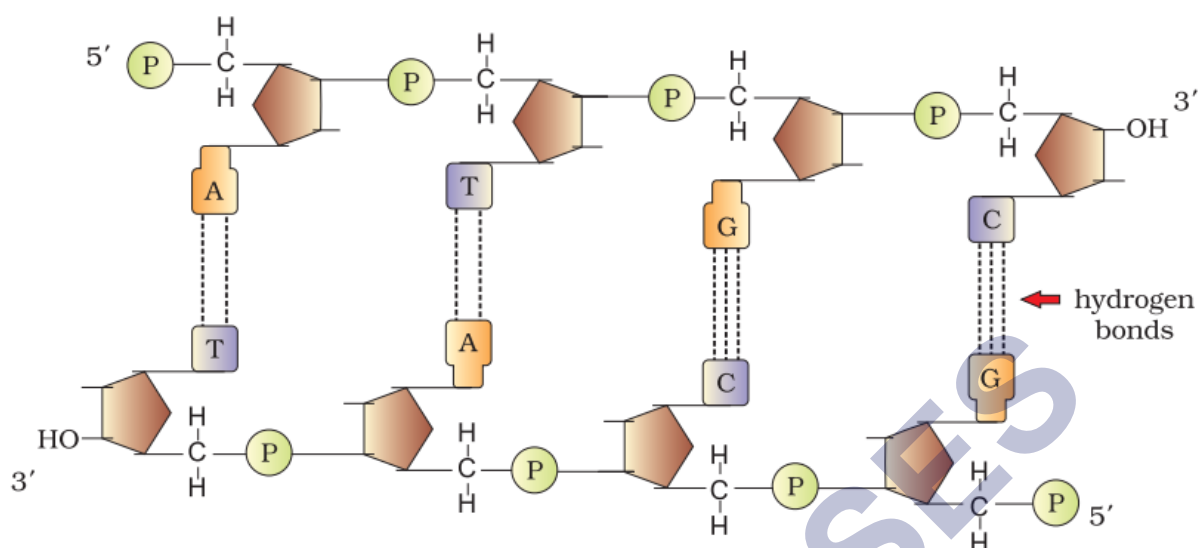

Francis Crick proposed the Central dogma in molecular biology, which states that the genetic information flows from DNA → RNA → Protein.

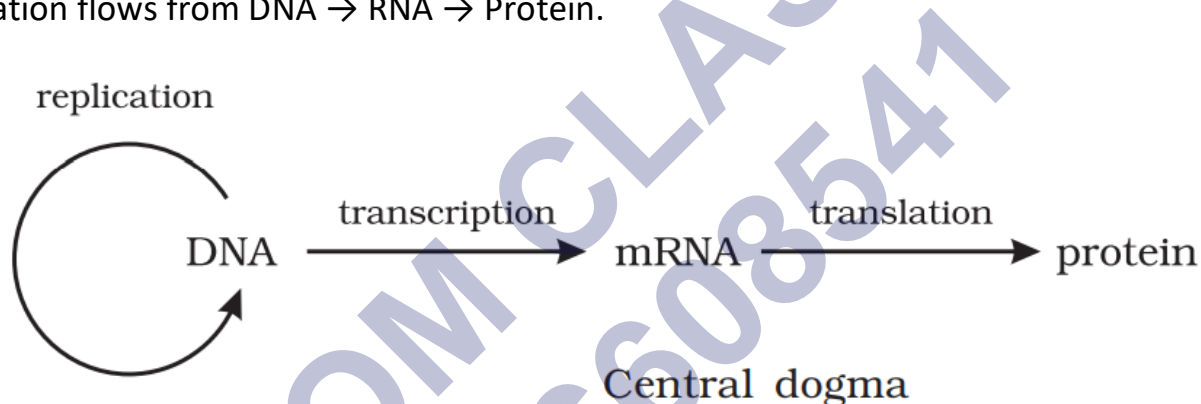

### Packing of DNA helix:

In prokaryotes, well defined nucleus is absent and negatively charged DNA is combined with some positively charged proteins called nucleoids.

In eukaryotes, histones, positively charged protein organized to form 8 molecules unit called histone octamer. Negatively charged DNA is wrapped around the histone octamer to form nucleosome. Histones are rich in the basic amino acid residues lysine's and arginine's. Both the amino acid residues carry positive charges in their side chains. Single nucleosome contains about 200 base pairs. Chromatin is the repeating unit of nucleosome.

In nucleus, some region of chromatin are loosely packed (and stains light) and are referred to as euchromatin. The chromatin that is more densely packed and stains dark are called as Heterochromatin. Euchromatin is transcriptionally active chromatin, whereas heterochromatin is inactive.

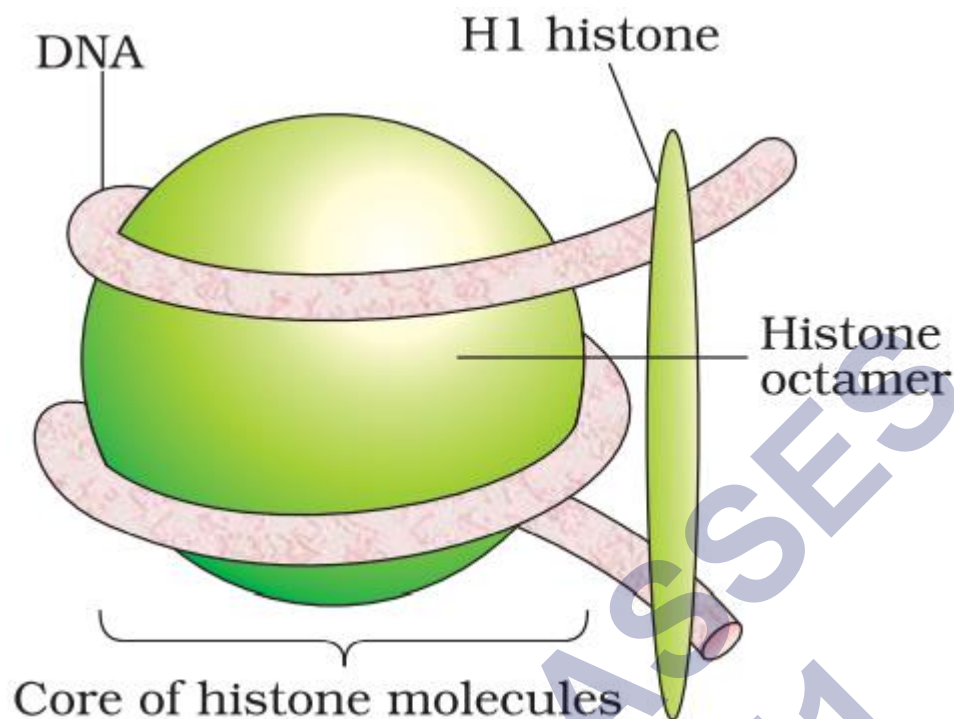

### Genetic Material DNA:

DNA acts as a genetic material took long to be discovered and proven. Gregor Mendel, Walter Sutton, Thomas Hunt Morgan and numerous other scientists had narrowed the search to the chromosomes located in the nucleus of most cells. In 1928, Frederick Griffith, in a series of experiments with *Streptococcus pneumoniae* (bacterium responsible for pneumonia), witnessed a miraculous transformation in the bacteria. When *Streptococcus pneumoniae* (pneumococcus) bacteria are grown on a culture plate, some produce smooth shiny colonies (S) while others produce rough colonies (R). This is because the S strain bacteria have a mucous (polysaccharide) coat, while R strain does not. Mice infected with the S strain (virulent) die from pneumonia infection but mice infected with the R strain do not develop pneumonia.

S strain → Inject into mice → Mice die

R strain → Inject into mice → Mice live

Griffith was able to kill bacteria by heating them. He observed that heat-killed S strain bacteria injected into mice did not kill them. When he injected a mixture of heat-killed S and live R bacteria, the mice died. Moreover, he recovered living S bacteria from the dead mice.

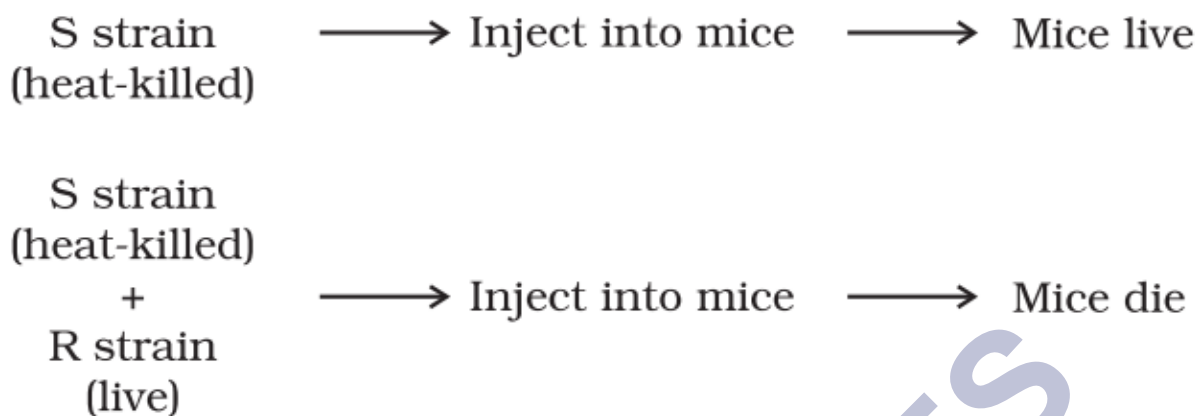

He concluded that the R strain bacteria had somehow been transformed by the heat-killed S strain bacteria. transferred from the heat-killed S strain, had enabled the R strain to synthesize a smooth polysaccharide coat and become virulent.

### The Hershey-Chase experiment:

Alfred Hershey and Martha Chase (1952). They worked with viruses that infect bacteria called bacteriophages. The bacteriophage attaches to the bacteria and its genetic material then enters the bacterial cell. it was protein or DNA from the viruses that entered the bacteria. They grew some viruses on a medium that contained radioactive phosphorus and some others on medium that contained radioactive sulfur. Viruses grown in the presence of radioactive phosphorus contained radioactive DNA but not radioactive protein because DNA contains phosphorus but protein does not. and viruses grown on radioactive sulfur contained radioactive protein but not radioactive DNA because DNA does not contain sulfur Radioactive phages were allowed to attach to E. coli bacteria. the viral coats were removed from the bacteria by agitating them in a blender. The virus particles were separated from the bacteria by spinning them in a centrifuge. Bacteria which was infected with viruses that had radioactive DNA indicating that DNA was the material that passed from the virus to the bacteria. Bacteria that were infected with viruses that had radioactive proteins were not radioactive. This indicates that proteins did not enter the bacteria from the viruses. DNA is therefore the genetic material that is passed from virus to bacteria.

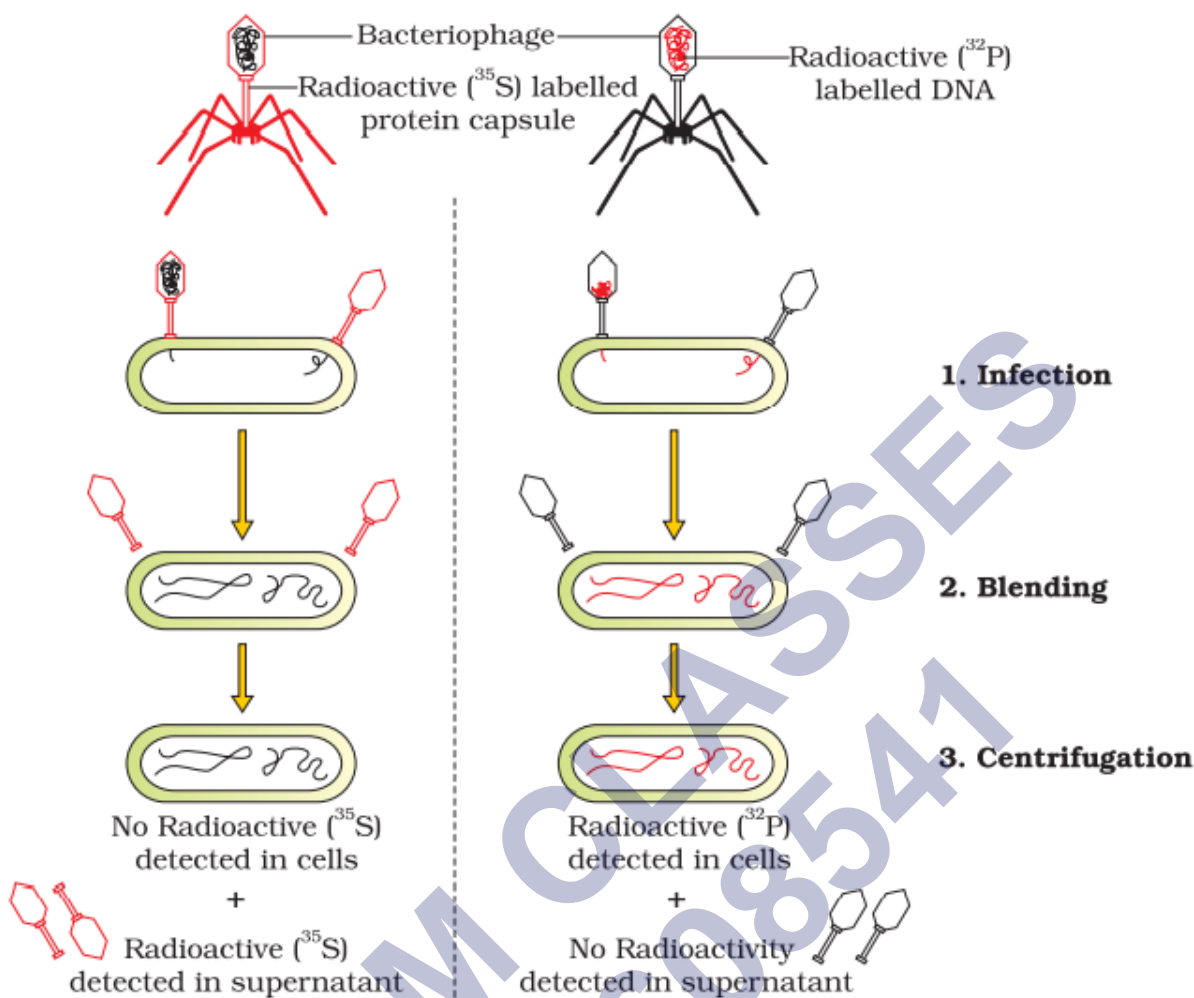

### Properties of Genetic Material:

- It should be able to generate its replica (replication).
- It should chemically and structurally be stable.
- It should provide the scope for slow changes (mutation) that are required for evolution.
- It should be able to express itself in the form of 'Mendelian Characters'.
- DNA is chemically less reactive but structurally more stable as compare to RNA. So, DNA is better genetic material.
- RNA used as genetic material as well as catalyst and more reactive so less stable. Therefore, DNA has evolved from RNA.

### DNA Replication:

The process of producing two identical copies of DNA from a single DNA molecule is called DNA replication. This section describes this whole process in detail, as it is a process of biological inheritance. Students will be familiar with many different terminologies which are associated with the process of DNA replication. You will know about semi-conservative replication, replication fork. This section further explains about leading strand and lagging





rRNAs play structural and catalytic role during translation.

### Transcription in prokaryotes:

**Initiation:** In this step, RNA polymerase enzyme and initiation factor binds at the promoter of DNA sequence and begin transcription.

**Elongation:** In this step RNA polymerase, enzyme nucleoside triphosphate behaves as a substrate and polymerases the nucleotides of templates as a complementary strand.

**Termination:** In this step rho, a terminator factor replaces the initiation factor at the DNA sequence termination point. At this stage RNA and RNA polymerase, an enzyme is separated with rho factor.

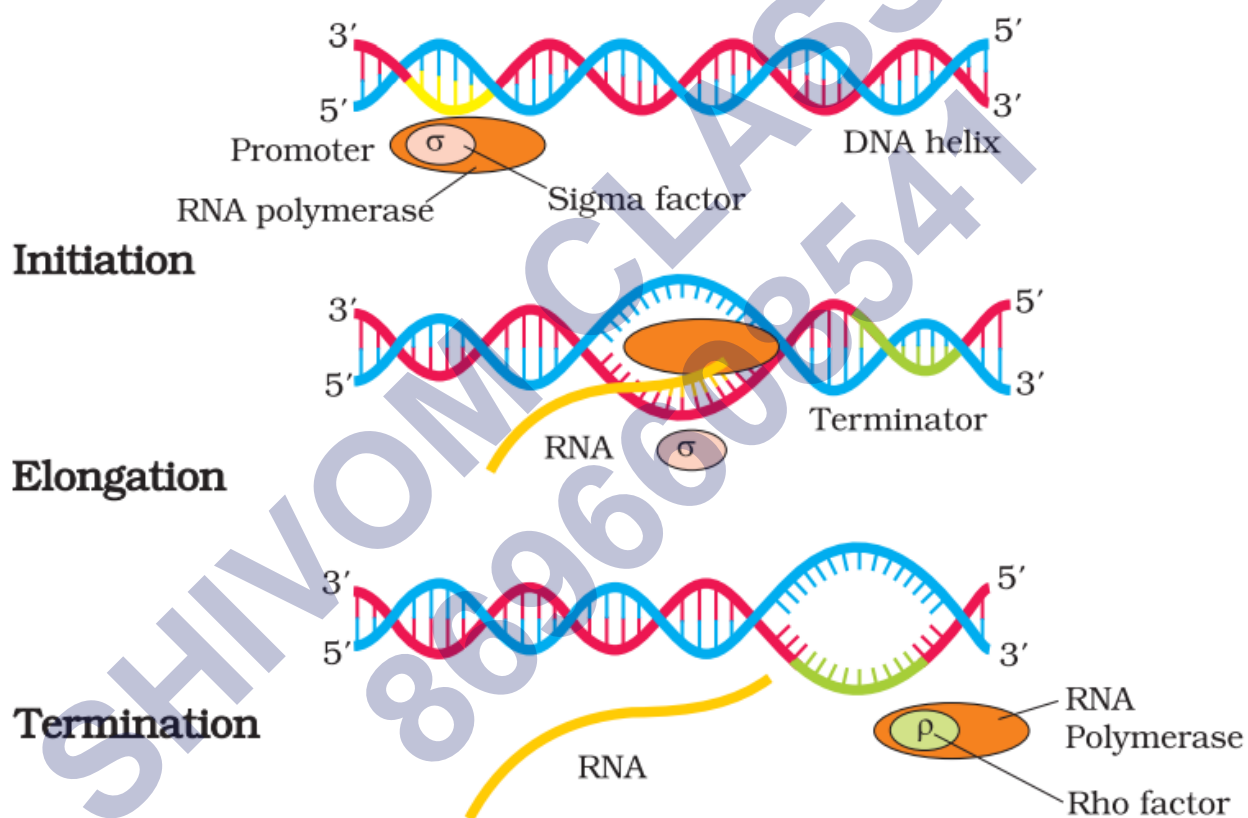

### Process of Transcription in Eukaryotes:

Three RNA polymerases in the nucleus (in addition to the RNA polymerase found in the organelles). The RNA polymerase I transcribes rRNAs (28S, 18S, and 5.8S), whereas the RNA polymerase III is responsible for transcription of tRNA, 5srRNA, and snRNAs (small nuclear RNAs). The RNA polymerase II transcribes precursor of mRNA, the heterogeneous nuclear RNA (hnRNA). the primary transcripts contain both the exons and the introns and are non-functional. hnRNA undergo two additional processing called as capping and tailing.

**Splicing:** where the introns are removed, and exons are joined in a defined order.

**Capping:** In capping an unusual nucleotide (methyl guanosine triphosphate) is added to the 5'-end of hnRNA.

**Tailing:** In tailing, adenylate residues (200-300) are added at 3'-end in a template independent manner. It is the fully processed hnRNA, now called mRNA, that is transported out of the nucleus for translation.

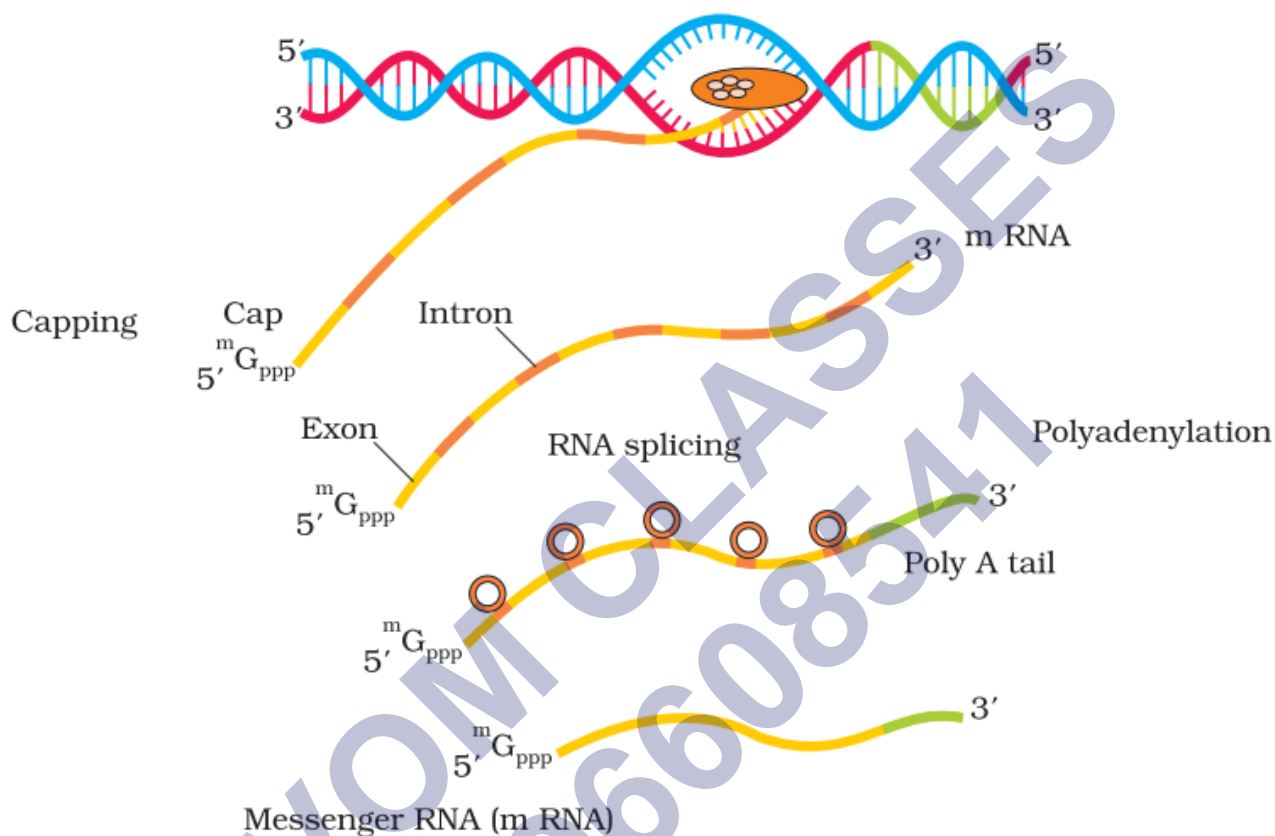

**Exons:** Exons are said to be those sequence that appear in mature or processed RNA.

**Introns:** Introns or intervening sequences do not appear in mature or processed RNA.

### The Machinery and the Enzymes:

In living cells, such as *E. coli*, the process of replication requires a set of catalysts (enzymes). The main enzyme is referred to as DNA-dependent DNA polymerase. These enzymes are highly efficient enzymes as they have to catalyse polymerization. *E. coli* that has only  $4.6 \times 10^6$  bp (compare it with human whose diploid content is  $6.6 \times 10^9$  bp) Any mistake during replication would result into mutations. energetically replication is a very expensive process.

### Replicating Fork:

For long DNA molecules, since the two strands of DNA cannot be separated in its entire length (due to very high energy requirement), the replication occur within a small opening of the DNA helix, referred to as replication fork. The DNA-dependent DNA polymerases catalyse

polymerisation only in one direction, that is  $5' \rightarrow 3'$ . on one strand (the template with polarity  $3' \rightarrow 5'$ ), the replication is continuous, while on the other (the template with polarity  $5' \rightarrow 3'$ ), it is discontinuous. The discontinuously synthesized fragments are later joined by the enzyme DNA ligase. The DNA polymerases on their own cannot initiate the process of replication. Also the replication does not initiate randomly at any place in DNA. There is a definite region in *E. coli* DNA where the replication originates. Such regions are termed as origin of replication. It is because of the requirement of the origin of replication that a piece of DNA if needed to be propagated during recombinant DNA procedures, requires a vector. The vectors provide the origin of replication.

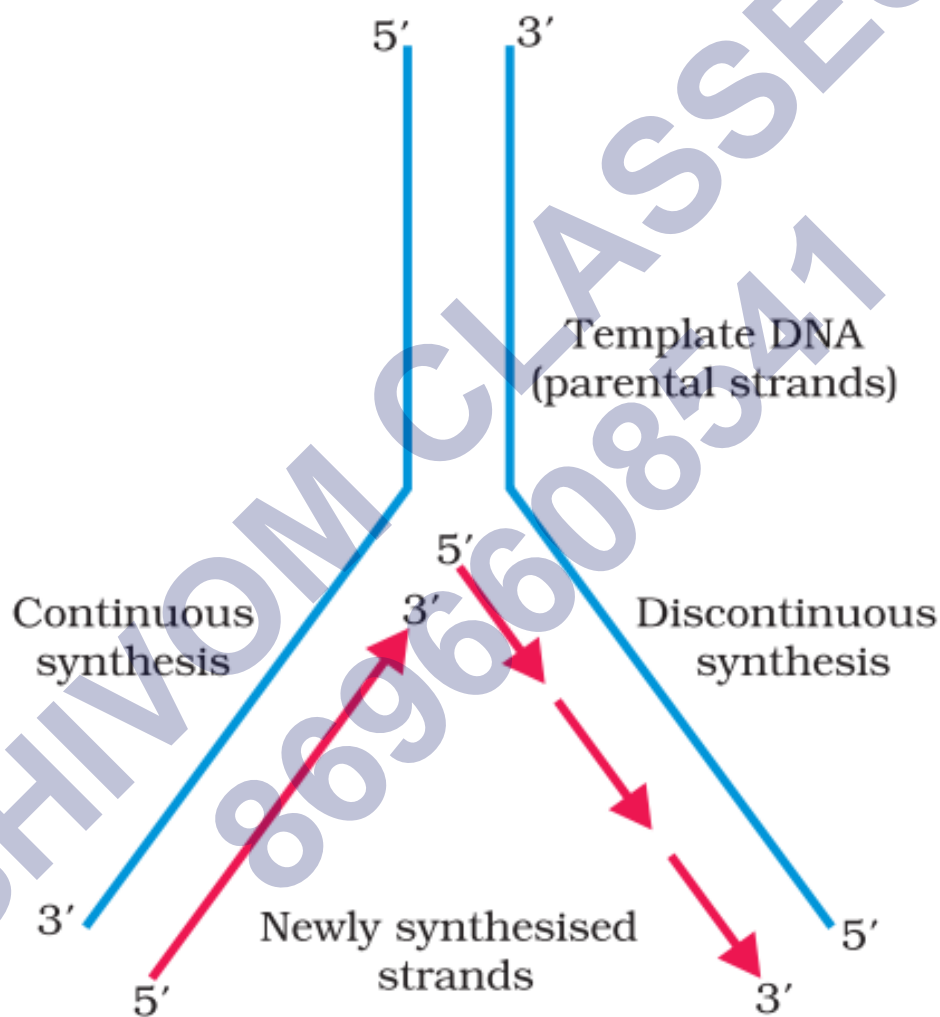

### Genetic Code:

- Genetic Code is the relationship of amino acids sequence in a polypeptide and nucleotide/ base sequence in mRNA. It directs the sequence of amino acids during synthesis of proteins.
- George Gamow suggested that genetic code should be combination of 3 nucleotides to code 20 amino acids.
- H.G. Khorana developed chemical method to synthesizing RNA molecules with defined combination of bases.

- Marshall Nirenberg's cell free system for protein synthesis finally helped the code to be deciphered.

	First position		Second position				Third position		
	U	C	U	C	A	G	U	C	A
U	UUU	Phe	UCU	Ser	UAU	Tyr	UGU	Cys	U
	UUC	Phe	UCC	Ser	UAC	Tyr	UGC	Cys	C
	UUA	Leu	UCA	Ser	UAA	Stop	UGA	Stop	A
	UUG	Leu	UCG	Ser	UAG	Stop	UGG	Trp	G
C	CUU	Leu	CCU	Pro	CAU	His	CGU	Arg	U
	CUC	Leu	CCC	Pro	CAC	His	CGC	Arg	C
	CUA	Leu	CCA	Pro	CAA	Gin	CGA	Arg	A
	CUG	Leu	CCG	Pro	CAG	Gin	CGG	Arg	G
A	AUU	Ile	ACU	Thr	AAU	Asn	AGU	Ser	U
	AUC	Ile	ACC	Thr	AAC	Asn	AGC	Ser	C
	AUA	Ile	ACA	Thr	AAA	Lys	AGA	Arg	A
	AUG	Met	ACG	Thr	AAG	Lys	AGG	Arg	G
G	GUU	Val	GCU	Ala	GAU	Asp	GGU	Gly	U
	GUC	Val	GCC	Ala	GAC	Asp	GGC	Gly	C
	GUA	Val	GCA	Ala	GAA	Glu	GGA	Gly	A
	GUG	Val	GCG	Ala	GAG	Glu	GGG	Gly	G

## The Codons for the Various Amino Acids

### Salient features of Genetic Code are:

- The code is triplet. 61 codons code for amino acids and 3 codons do not code for any amino acids called stop codon (UAG, UGA and UAA).
- Codon is unambiguous and specific, code for one amino acid.
- The code is degenerate. Some amino acids are coded by more than one codon.
- The codon is read in mRNA in a contiguous fashion without any punctuation.
- The codon is nearly universal. AUG has dual functions. It codes for methionine and also act as initiator codon.

### Mutations and Genetic code:

A change of single base pair (point mutation) in the 6th position of Beta globin chain of Hemoglobin results due to the change of amino acid residue glutamate to valine. These results into diseased condition called sickle cell anemia. Insertion and deletion of three or its multiple bases insert or delete one or multiple codons hence one or more amino acids and reading frame remain unaltered from that point onwards. Such mutations are called frame-shift insertion or deletion mutations.

### tRNA– the Adapter Molecule:

The t-RNA called as adaptor molecules. It has an anticodon loop that has bases complementary to code present on mRNA and also has an amino acid acceptor to which amino acid binds. t-RNA is specific for each amino acids.

The secondary structure of t-RNA is depicted as clover-leaf. In actual structure, the t-RNA is a compact molecule which look like inverted L.

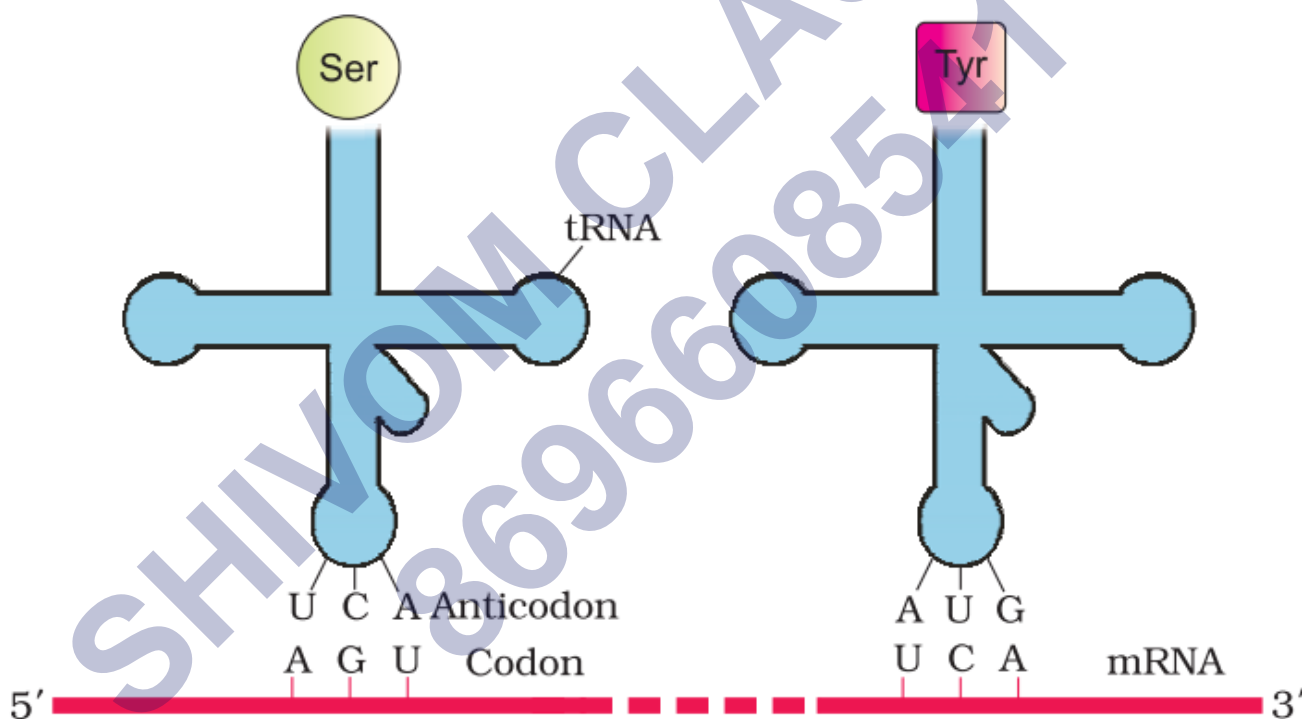

### Translation process:

Translation is the process of polymerization of amino acids to form a polypeptide. The order and sequence of amino acids are defined by the sequence of bases in the mRNA. Amino acids are joined by peptide bonds.

### It involved following steps:

Charging of t-RNA.

Formation of peptide bonds between two charged tRNA.

The start codon is AUG. An mRNA has some additional sequence that are not translated called untranslated region (UTR).

For initiation ribosome binds to mRNA at the start codon. Ribosomes moves from codon to codon along mRNA for elongation of protein chain. At the end release factors binds to the stop codon, terminating the translation and release of polypeptide form ribosome.

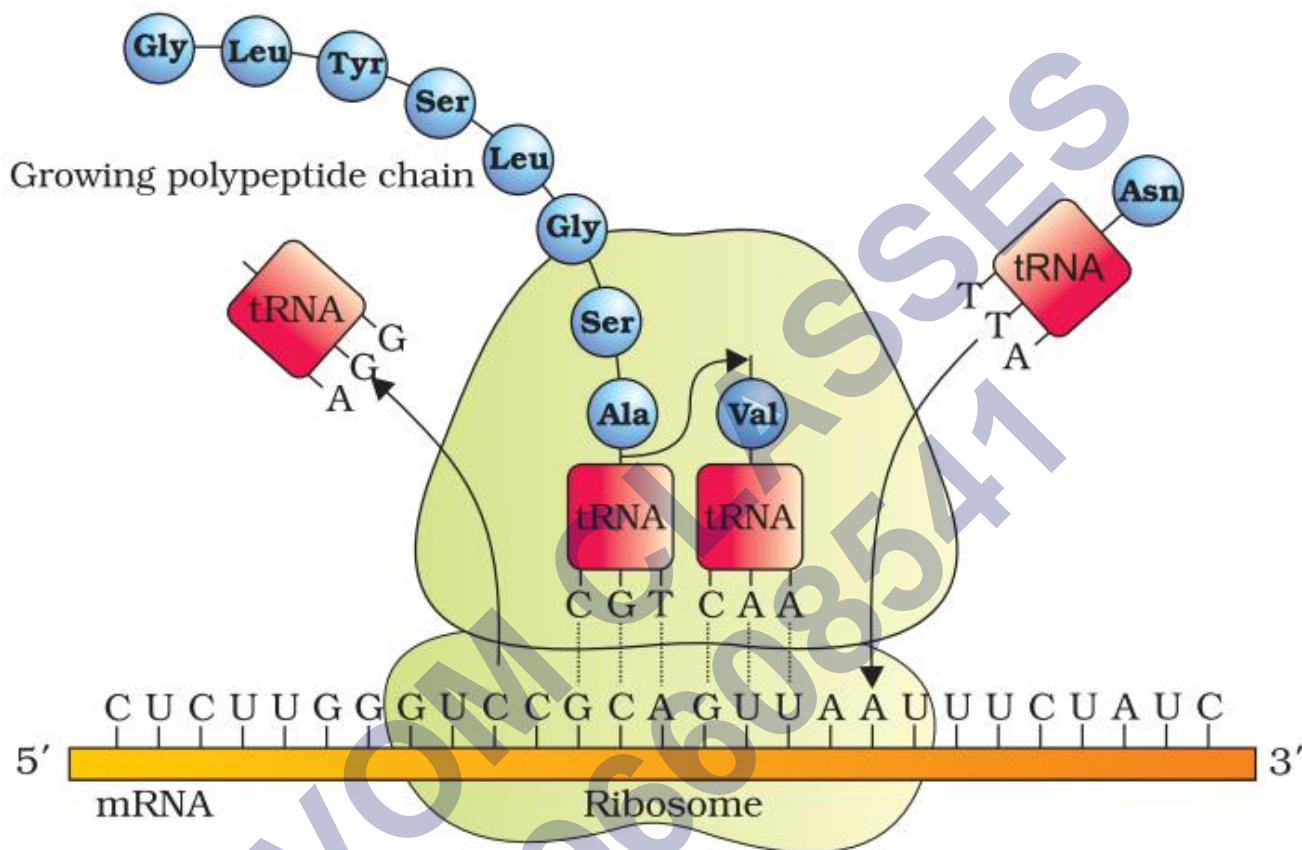

### Regulation of Gene Expression:

All the genes are not needed constantly. The genes needed only sometimes are called regulatory genes and are made to function only when required and remain non-functional at other times. Such regulated genes, therefore required to be switched 'on' or 'off' when a particular function is to begin or stop.

### The Lac Operon:

Lac operon consists of one regulatory gene (i) and three structural genes (y, z and a). Gene i code for the repressor of the lac operon. The z gene code for beta-galactosidase, that is responsible for hydrolysis of disaccharide, lactose into monomeric units, galactose and glucose. Gene y code for permease, which increases permeability of the cell. Gene a encode for transacetylase.

Lactose is the substrate for enzyme beta-galactosidase and it regulates switching on and off of the operon, so it is called inducer.

Regulation of Lac operon by repressor is referred as negative regulation. Operation of Lac operon is also under the control of positive regulation.

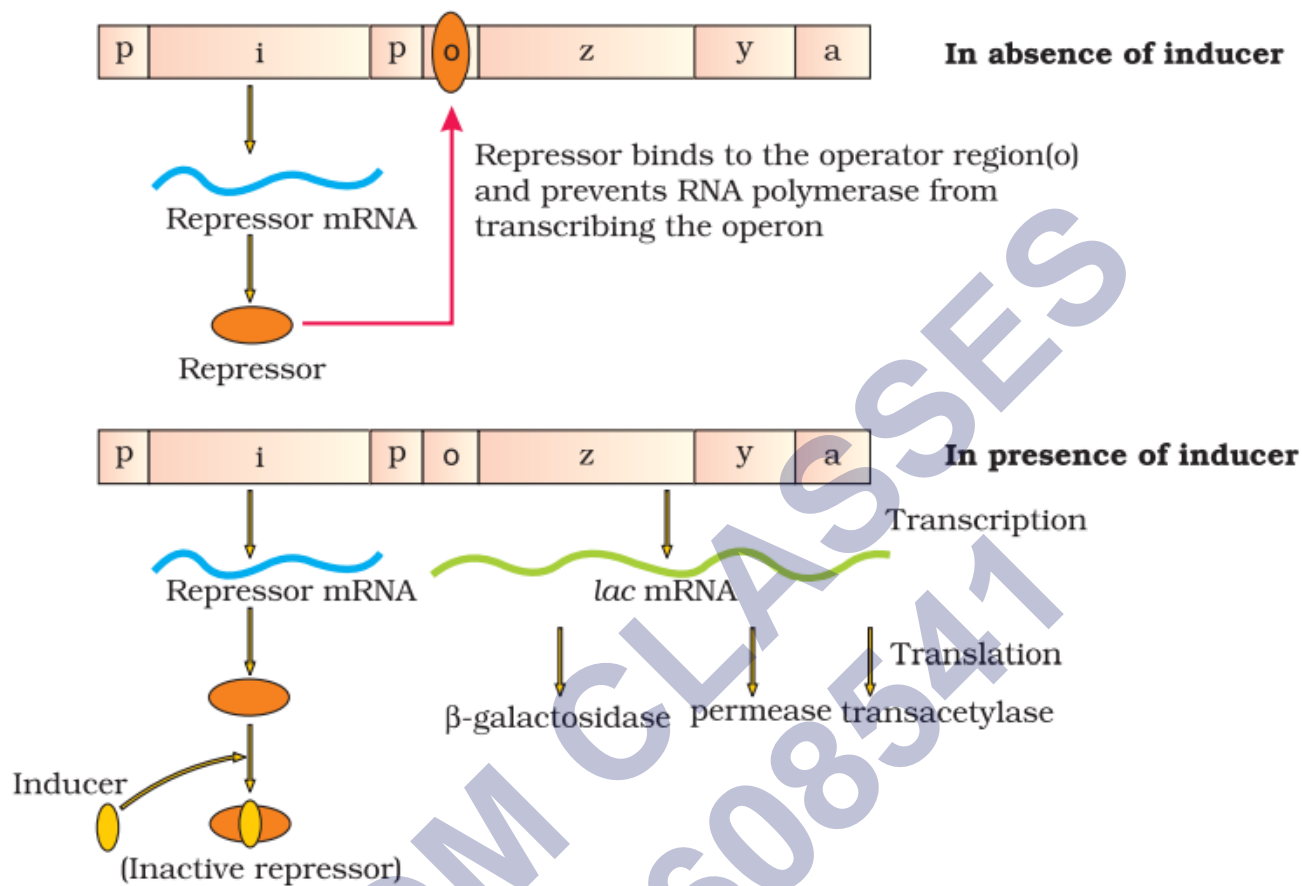

### Human Genome Project (HGP):

Human Genome Project was launched in 1990 to find out the complete DNA sequence of human genome using genetic engineering technique and bioinformatics to isolate and clone the DNA segment for determining DNA sequence.

The project was coordinated by the US Department of Energy and the National Institute of health.

The method involved the two major approaches- first identifying all the genes that express as RNA called Express sequence tags (EST).The second is the sequencing the all set of genome that contained the all the coding and non-coding sequence called sequence Annotation.

### Goal of HGP:

- Identify all the genes (20,000 to 25,000) in human DNA.
- Determine the sequence of the 3 billion chemical base pairs that make up human DNA.
- Store this information in data base.
- Improve tools for data analysis.
- Transfer related information to other sectors.



- To address the legal, ethical and social issues that may arise due to project.

### Salient features of Human Genome:

- The human genome contains 3164.7 million nucleotide bases.
- The average gene consists of 3000 bases, but sizes vary greatly, with the largest known human gene being dystrophin at 2.4 million bases.
- Less than 2 per cent of the genome codes for proteins.
- Repeated sequences make up very large portion of the human genome.
- Repetitive sequences are stretches of DNA sequences that are repeated many times, sometimes hundred to thousand times.
- Chromosome 1 has most genes (2968), and the Y has the fewest (231).
- Scientists have identified about 1.4 million locations where single base DNA differences (SNPs – single nucleotide polymorphism) occur in humans.

### DNA Fingerprinting:

Satellite DNA regions are stretches of repetitive DNA which do not code for any specific protein. These non-coding sequences form a major chunk of the DNA profile of humans. They depict a high level of polymorphism and are the basis of DNA fingerprinting. These genes show a high level of polymorphism in all kind of tissues as a result of which they prove to be very useful in forensic studies.

Any piece of DNA sample found at a crime scene can be analyzed for the level of polymorphism in the non-coding repetitive sequences. After the DNA profile is traced, it becomes easier to find the criminal by performing the DNA fingerprinting for the suspects.

Apart from crime scenes, Fingerprinting applications also prove useful in finding the parents of an unclaimed baby by conducting a paternity test on a DNA sample from the baby.

### DNA Fingerprinting Steps:

Alec Jeffreys developed this technique in which he used satellite DNAs also called VNTRs (Variable Number of Tandem Repeats) as a probe because it showed the high level of polymorphism.

Following are the steps involved in DNA fingerprinting:

Isolating the DNA.

Digesting the DNA with the help of restriction endonuclease enzymes.

Separating the digested fragments as per the fragment size by the process of

Blotting the separated fragments onto synthetic membranes like nylon.

Hybridising the fragments using labelled VNTR probes.

Analysing the hybrid fragments using autoradiography.

### DNA Fingerprinting Applications:

As discussed earlier the technique of fingerprinting is used for DNA analysis in forensic tests and paternity tests. Apart from these two fields, it is also used in determining the frequency of a particular gene in a population which gives rise to diversity. In case of the change in gene frequency or genetic drift, Fingerprinting can be used to trace the role of this change in evolution.

SHIVOM CLASSES  
8696608541

Class : 12th Biology  
Chapter- 6 : Molecular Basis of Inheritance (Part-I)

Sequence of nucleotides (nitrogen bases) in mRNA that contains information for protein synthesis (translation).

Defination

- Genetic Code**
- Triplet
  - Non-ambiguous
  - Degenerate
  - Comma less
  - Universal
  - Comma less

Features

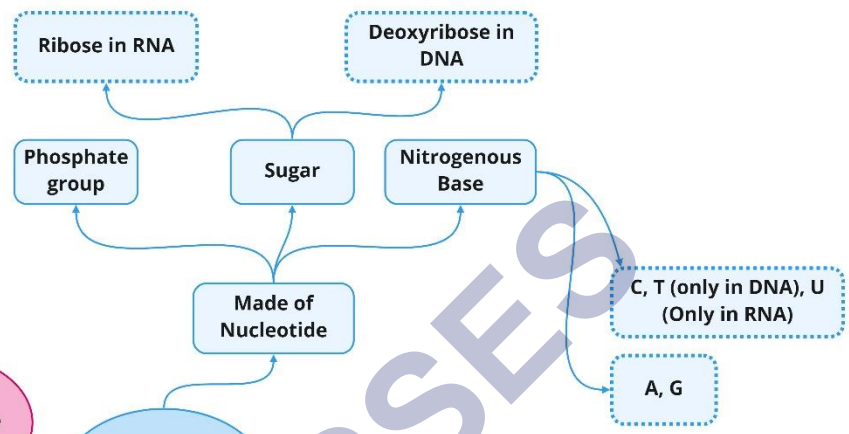

**Polynucleotide Chain**

**Human Genome Project**

- To identify all the estimated genes in human DNA
- To determine the sequences of the 3 billion base pairs
- To provide tools for data analysis

**Molecular Basis of Inheritance**

**Hershey and chase exp**

**Search for genetic material**

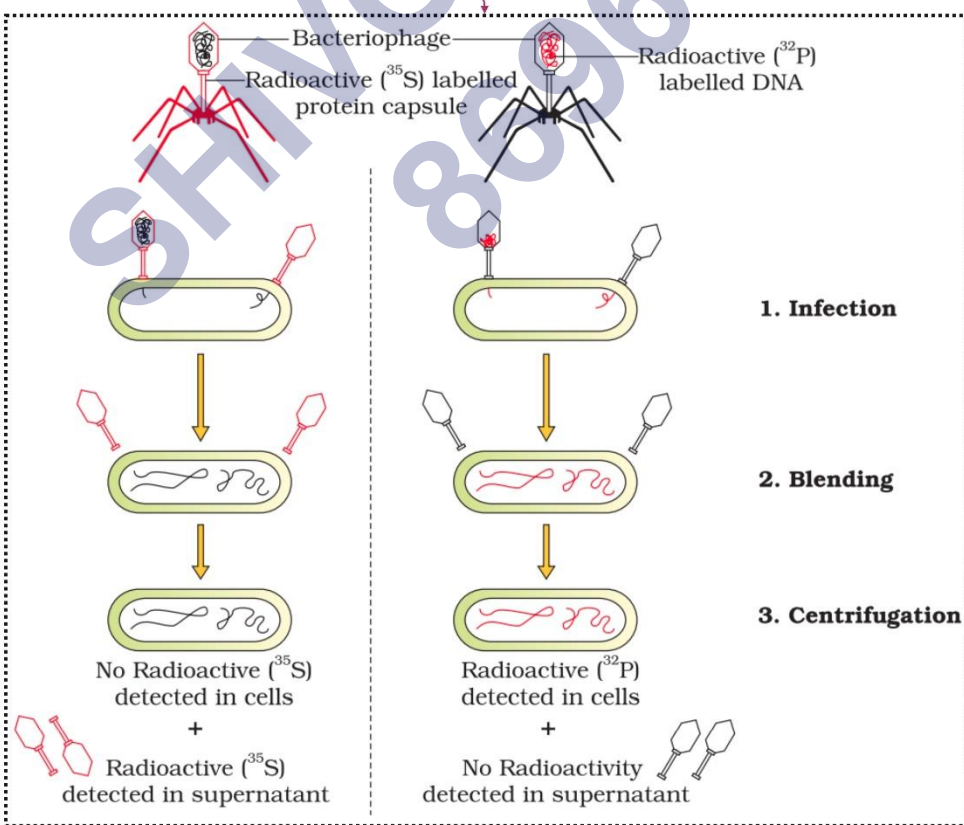

**Biochemical Nature**

**Griffith Exp**

- Discovered by Oswald Avery, Colin MacLeod and Maclyn McCarty.
- Conclusion: DNA is the hereditary material

- S-strain → Inject into mice → Mice die
- R-strain → Inject into mice → Mice live
- S-strain (Heat killed) → Inject into mice → Mice live
- S-strain (Heat killed) + R-strain (live) → Inject into mice → Mice die
- Conclusion: Some 'transforming principle', transferred from heat-killed S-strain to R-strain.

Class : 12th Biology  
Chapter - 6 : Molecular Basis of Inheritance (Part-II)

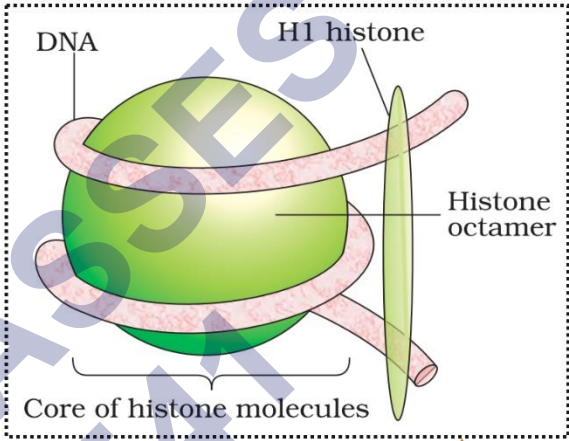
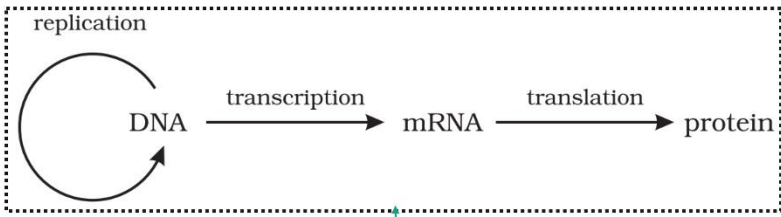

- Structural gene
- Operator gene
- Promoter gene
- Repressor
- Inducer

Gene expression and regulation

Central Dogma

The operon controlling lactose metabolism

Lac Operon

Molecular Basis of Inheritance

DNA packaging Nucleosome

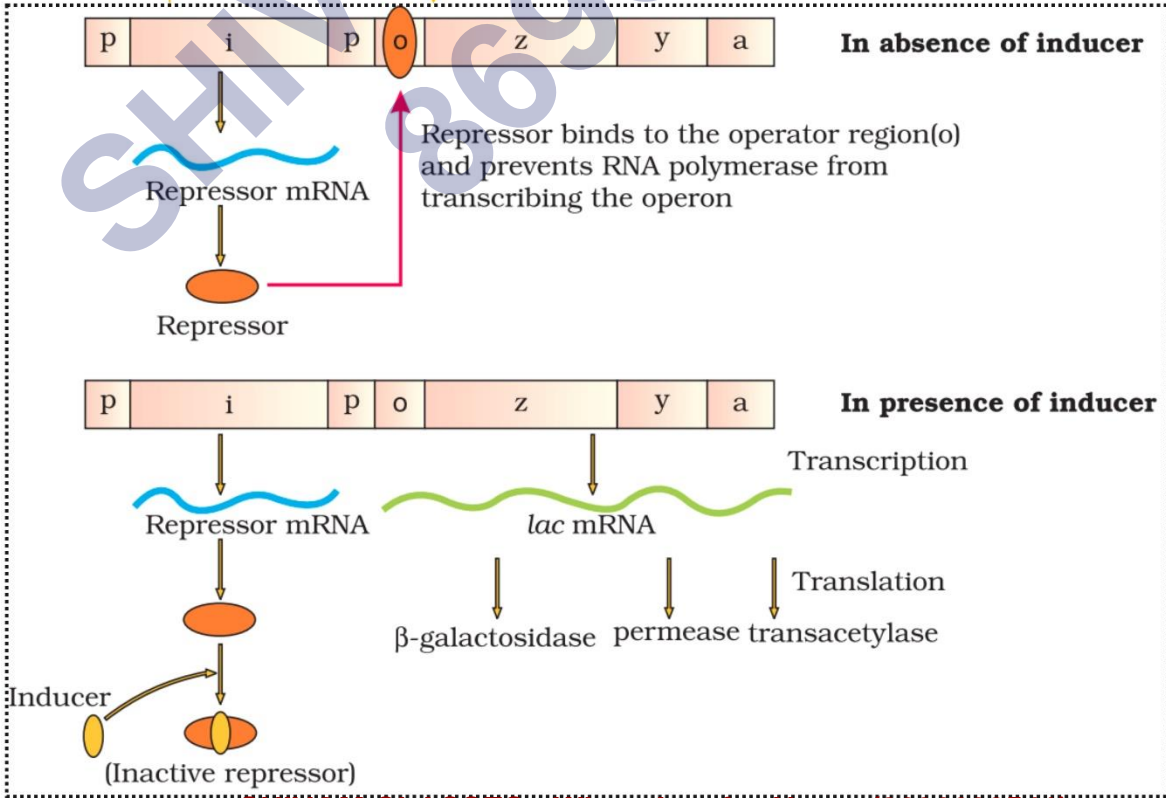

Class : 12th Biology  
Chapter - 6 : Molecular Basis of Inheritance (Part-III)

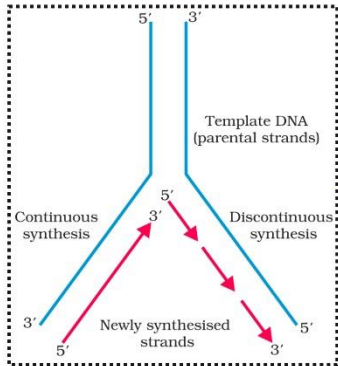
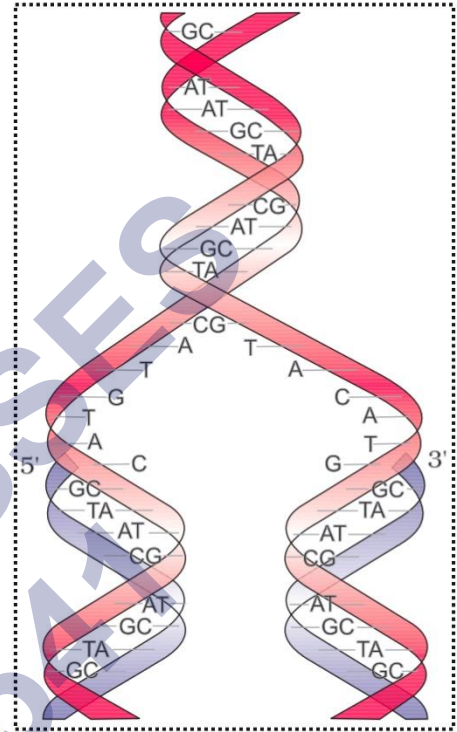
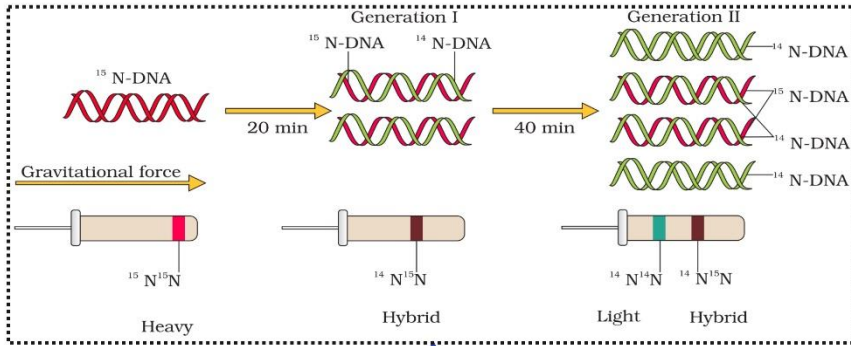

Meselson and stahl experiment

Process

Replication

Semi-conservative DNA Replication

Molecular Basis of Inheritance

Translation

Transcription

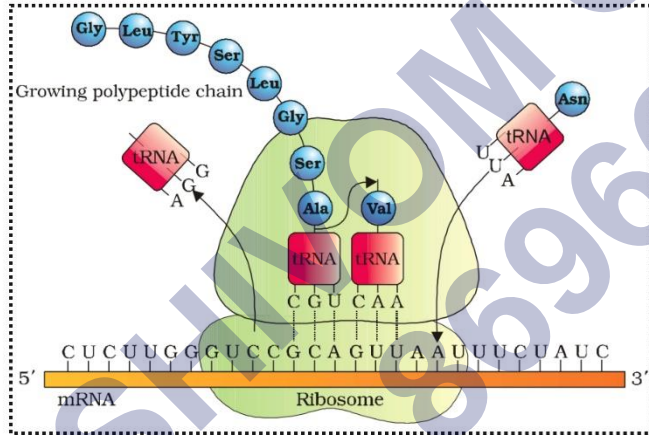

In Prokaryotes

In Eukaryotes

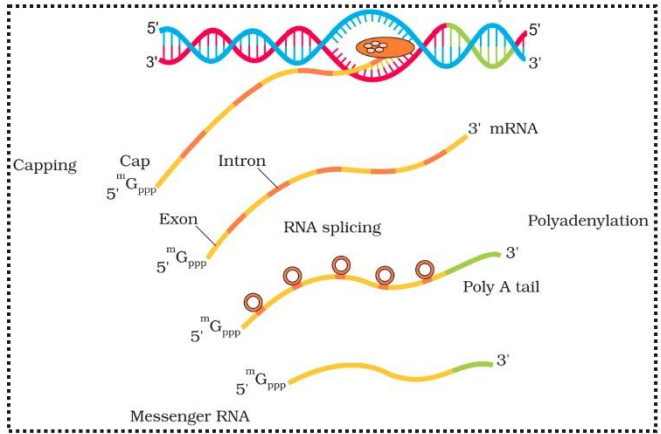
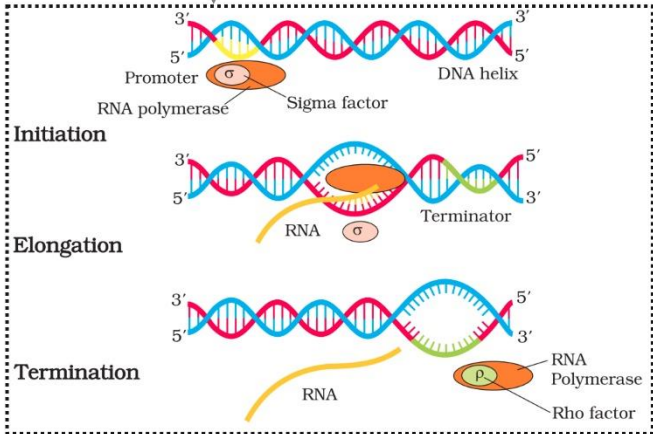

Class : 12th Biology  
Chapter- 6 : Molecular Basis of Inheritance (Part-II)

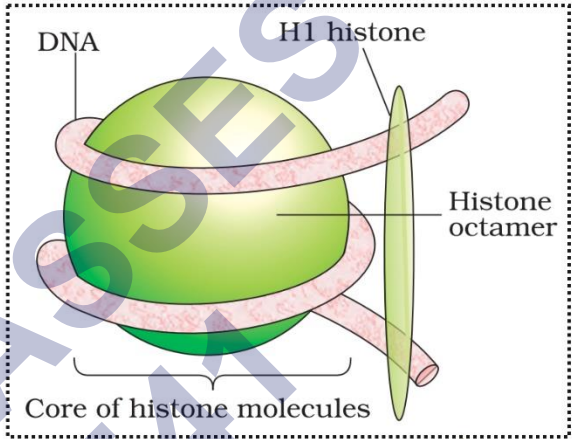
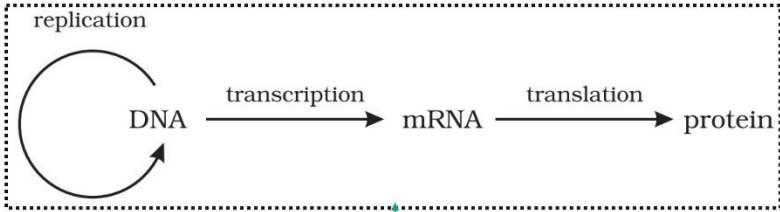

- Structural gene
- Operator gene
- Promoter gene
- Repressor
- Inducer

Gene expression and regulation

Central Dogma

The operon controlling lactose metabolism

Lac Operon

Molecular Basis of Inheritance

DNA packaging Nucleosome

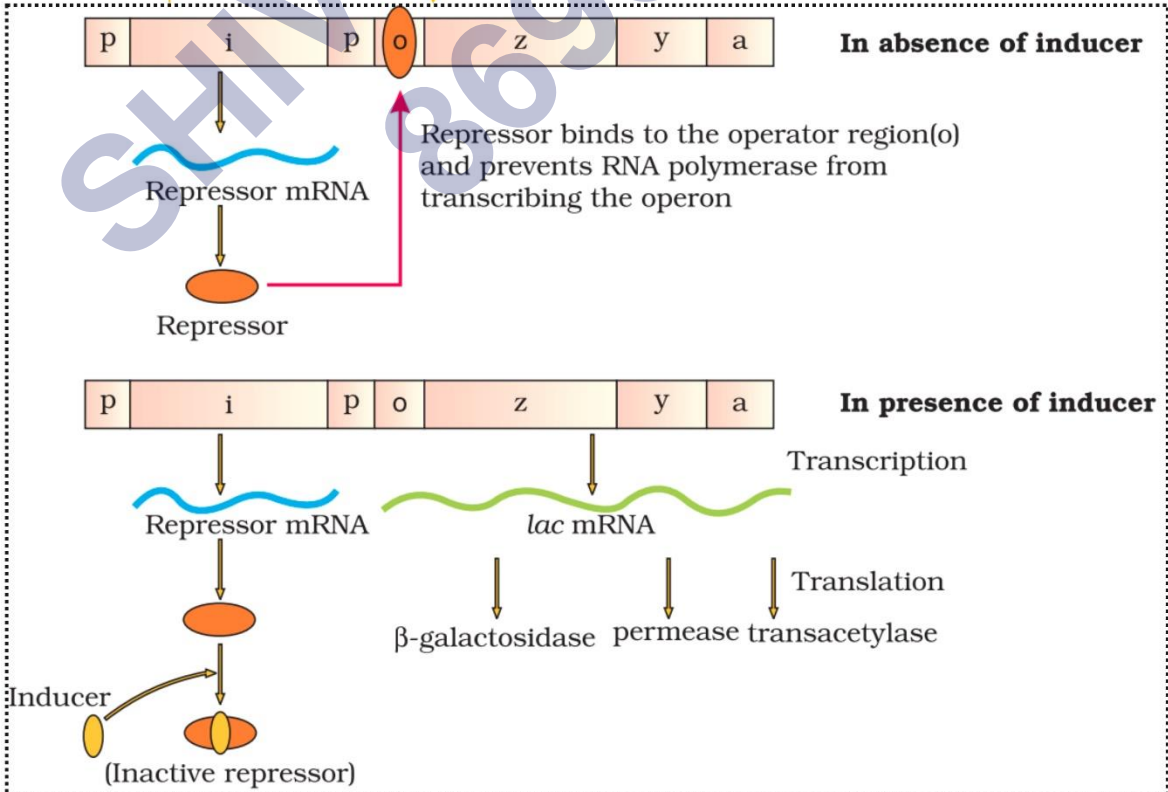

## Important Questions

### ➤ Multiple Choice Questions:

- Who proved semiconservative mode of DNA replication for the first time in *E. coli* with the help of  $N^{15}$  heavy nitrogen isotope?
  - Watson and Crick
  - Kornberg and Ochova
  - Messelson and Stahl
  - Luria and Delbruck
- A nucleoside differs from a nucleotide. It lacks the:
  - base
  - sugar
  - phosphate group
  - hydroxyl group.
- Both deoxyribose and ribose belong to a class of sugars called:
  - trioses
  - hexoses
  - pentoses
  - polysaccharides.
- The fact that a purine base always paired through hydrogen bonds with a pyrimidine base leads to, in the DNA double helix:
  - the antiparallel nature
  - the semiconservative nature
  - uniform width throughout DNA
  - uniform length in all DNA.
- The net electric charge on DNA and histones is:
  - both positive
  - both negative
  - negative and positive, respectively
  - zero
- The promoter site and the terminator site for transcription are located at:
  - 3' (downstream) end and 5' (upstream) end, respectively of the transcription unit
  - 5' (upstream) end and 3' (downstream) end, respectively of the transcription unit
  - the 5' (upstream) end
  - the 3' (downstream) end.



7. Which of the following statements is the most appropriate for sickle cell anaemia?
- (a) It cannot be treated with iron supplements.
  - (b) It is a molecular disease.
  - (c) It confers resistance of acquiring malaria.
  - (d) All of the above.
8. One of the following is true with respect to AUG
- (a) It codes for methionine only.
  - (b) It is also an initiation codon.
  - (c) It codes for methionine in both prokaryotes and eukaryotes.
  - (d) All of the above.
9. The first genetic material could be:
- (a) protein
  - (b) carbohydrates
  - (c) DNA
  - (d) RNA.
10. With regard to mature mRNA in eukaryotes:
- (a) exons and introns do not appear in the mature RNA
  - (b) exons appear but introns do not appear in the mature RNA
  - (c) introns appear but exons do not appear in the mature RNA
  - (d) both exons and introns appear in the mature RNA.
11. The human chromosome with the highest and least number of genes in them are respectively:
- (a) Chromosome 21 and Y
  - (b) Chromosome 1 and X
  - (c) Chromosome 1 and Y
  - (d) Chromosome X and Y.
12. Who amongst the following scientists had no contribution in the development of the double helix model for the structure of DNA?
- (a) Rosalind Franklin
  - (b) Maurice Wilkins
  - (c) Erwin Chargaff
  - (d) Meselson and Stahl.
13. DNA is a polymer of nucleotides which are linked to each other by 3'-5' phosphodiester bond. To prevent polymerisation of nucleotides, which of the following modifications would you choose?
- (a) Replace purine with pyrimidines

- (b) Remove/Replace 3' OH group in deoxyribose
- (c) Remove/Replace 2' OH group with some other group in deoxyribose
- (d) Both 'B' and 'C'.

14. Which of the following steps in transcription is catalysed by RNA polymerase?

- (a) Initiation
- (b) Elongation
- (c) Termination
- (d) All of the above.

15. Control of gene expression takes place at the level of:

- (a) DNA-replication
- (b) Transcription
- (c) Translation
- (d) None of the above

### ➤ Very Short Question:

1. Name the factors for RNA polymerase enzyme which recognises the start and termination signals on DNA for transcription process in Bacteria.
2. Mention the function of non-histone protein.
3. During translation what role is performed by tRNA
4. RNA viruses mutate and evolve faster than other viruses. Why?
5. Name the parts 'X' and 'Y' of the transcription unit given below.
6. Mention the dual functions of AUG.
7. Name the process in which unwanted mRNA regions are removed & wanted regions are joined.
8. Give the initiation codon for protein synthesis. Name the amino acid it codes for?
9. In which direction, the new strand of DNA synthesised during DNA replication.
10. What is the function of amino acyl tRNA synthetase.

### ➤ Short Questions:

1. Give two reasons why both the strands of DNA are not copied during transcription.
2. Mention any two applications of DNA fingerprinting.
3. State the 4 criteria which a molecule must fulfill to act as a genetic material.
4. "DNA polymerase plays a dual function during DNA replication" comment on statement?
5. Three codons on mRNA are not recognised by tRNA what are they? What is the general term used for them what is their significance in protein synthesis?
6. Give two reasons why both the strands of DNA are not copied during DNA transcription?

7. Why is it essential that tRNA binds to both amino acids & mRNA codon during protein synthesis?
8. Explain what happens in frameshift mutation? Name one disease caused by the disorder?

### ➤ Long Questions:

1. Write a note on messenger RNA.
2. What is genetic code? List the properties of genetic code.
3. What is the role of ribosomes during translation? Ribosomes move along mRNA molecules and catalyze the assembly of amino acids into protein chains.

### ➤ Assertion and Reason Questions:

1. For question, two statements are given-one labelled Assertion and the other labelled Reason. Select the correct answer to these questions from the codes (a), (b), (c) and (d) as given below.

- a) Both assertion and reason are true, and reason is the correct explanation of assertion.
- b) Both assertion and reason are true, but reason is not the correct explanation of assertion.
- c) Assertion is true, but reason is false.
- d) Both assertion and reason are false

**Assertion:** Regulator and operator genes are not associated with constitutive genes

**Reason:** Constitutive genes need not be repressed.

2. For question, two statements are given-one labelled Assertion and the other labelled Reason. Select the correct answer to these questions from the codes (a), (b), (c) and (d) as given below.

- a) Both assertion and reason are true, and reason is the correct explanation of assertion.
- b) Both assertion and reason are true, but reason is not the correct explanation of assertion.
- c) Assertion is true, but reason is false.
- d) Both assertion and reason are false

**Assertion:** Lactose in lac operon is promoter gene.

**Reason:** Lactose inactivates the repressor gene.

### ➤ Case Study Questions:

1. Read the following and answer any four questions from (i) to (v) given below:

RNA or ribonucleic acid is a single chain polyribonucleotide which functions as carrier of coded genetic or hereditary information from DNA to cytoplasm for taking part in protein and enzyme synthesis. Six types of RNAs are ribosomal, transfer, messenger, genomic, small nuclear and small cytoplasmic RNA. Out of these, rRNA, mRNA and tRNA are major classes of RNAs that are involved in gene expression.

- (i) Which one is referred to a soluble RNA?

- a) mRNA
- b) tRNA
- c) rRNA
- d) hnRNA

(ii) The RNA that picks up specific amino acid from amino acid pool in the cytoplasm to ribosome during protein synthesis is?

- a) rRNA
- b) hnRNA
- c) mRNA
- d) tRNA

(iii) Which of the following is found in both DNA and messenger RNA?

- a) Double helix structure
- b) Ribose
- c) Sugar-phosphate chain
- d) Thymine

(iv) Which of the following statements regarding RNA is correct?

- a) Messenger RNAs carries coded information for synthesis of polypeptide.
- b) Ribosomal RNAs bind with tRNA to catalyse the formation of phosphodiester bonds.
- c) Genomic RNA is always single stranded.
- d) Synthesis of rRNA occurs in cytoplasm by RNA polymerase III

(v) In studying a virus, you find the following proportions of nitrogenous bases present: adenine 23%, guanine 37%, cytosine 23% uracil 17%. Which of the following statement(s) regarding this virus is/are correct?

- I. It probably uses RNA as its genetic material.
- II. The genetic material of this virus is probably single stranded.
- III. Base pairing rules in virus in this virus include adenine: cytosine.

- a) I only
- b) I and II only
- c) II and III only
- d) All of these.

2. Read the following and answer any four questions from (i) to (v) given below:

DNA fingerprinting is a technique of determining nucleotide sequences of certain areas of DNA which are unique to each individual. Each person has a unique DNA fingerprint. Each fingerprint is the same for every cell, tissue and organ of a person. DNA fingerprinting is the basis of paternity testing in case of disputes.

(i) The technique developed to identify a person with the help of DNA restriction analysis is known as.

- a) DNA profiling
- b) DNA fingerprinting
- c) RFLP
- d) Both (a) and (b).

(ii) For DNA fingerprinting, DNA is obtained from.

- a) Blood
- b) Hair root cells
- c) Semen
- d) All of these

(iii) During DNA fingerprinting, the radioactive probes.

- a) Hybridise with DNA sample to form double stranded structure
- b) Egrade the DNA
- c) Create positive charge on DNA
- d) Cut the DNA sample at various sites.

(iv) In India, DNA fingerprinting technique was developed by?

- a) Dr. Lalji Singh
- b) Alec Jeffreys
- c) Dr. Khorana
- d) None of these.

(v) Which of the following is true about DNA fingerprinting?

- a) VNTR is used as probe.
- b) DNA samples are loaded on agarose gel electrophoresis.
- c) It is based on identification of nucleotide sequence present on the DNA molecule.
- d) All of these

✓ Answer Key-

### ➤ Multiple Choice Answers:

1. (c) Messelson and Stahl
2. (c) phosphate group
3. (c) pentoses
4. (c) uniform width throughout DNA
5. (c) negative and positive, respectively
6. (b) 5' (upstream) end and 3' (downstream) end, respectively of the transcription unit
7. (d) All of the above.
8. (d) All of the above.

9. (d) RNA.
10. (b) exons appear but introns do not appear in the mature RNA
11. (c) Chromosome 1 and Y
12. (d) Meselson and Stahl.
13. (b) Remove/ Replace 3' OH group in deoxyribose
14. (b) Elongation
15. (b) Transcription

### ➤ Very Short Answers:

1. Sigma (s) factor and Rho(p) factor)
2. Packaging of chromatin
3. (i) Structural role  
(ii) Transfer of amino acid.
4. -OH group is present on RNA, which is a reactive group so it is unstable and mutates faster.
5. X – Template strand, Y – Terminator.
6. (i) Acts as initiation codon for protein synthesis  
(ii) It codes for methionine.
7. RNA splicing.
8. Initiation codon – AUG & it codes for methionine.
9. 5' → 3'
10. Amino acyl tRNA synthetase catalyses activation of amino and attachment of activated amino acids to the 3'-end of specific tRNA molecule.

### ➤ Short Answer:

1. (a) If both the strands act as a template, they would code for RNA with different sequences. This in turn would code for proteins with different amino acid sequences. This would result in one segment of DNA coding for two different proteins, hence complicating the genetic information transfer machinery.  
(b) If two RNA molecules were produced simultaneously, double stranded RNA complementary to each other would be formed. This would prevent RNA from being translated into proteins.
2. Ans.
  - (i) To identify criminals in the forensic laboratory.
  - (ii) To determine the real or biological parents in case of disputes.
  - (iii) To identify racial groups to rewrite the biological evolution. (Any two)

3. Ans.
  - (i) It should be able to generate its replica.
  - (ii) Should be chemically and structurally stable.
  - (iii) Should be able to express itself in the form of Mendelian characters.
  - (iv) Should provide the scope for slow changes (mutations) that are necessary for evolution.
4. DNA polymerase plays a dual function –it helps in synthesis of new strand & also helps in proof reading i.e replacement of RNA strands lay DNA fragments.
5. UAG UAA & UGA are the three codons that are not recognised by tRNA these are known as stop codon or non-sense codon. Since these three codons are not recognised by any tRNA they help in termination of protein chain during translation.
6. (i) If both the strands code for RNA two different RNA molecules & two different proteins would be formed hence genetic machinery would become complicated  
(ii) Since the two RNA molecules would be complementary to each other, they would wind together to form dsRNA without carrying out translation which means process of transcription would be futile
7. It is essential that tRNA binds to both amino acids & mRNA codon because tRNA acts as an adapter molecule with picks up a specific activated amino acid from the cytoplasm & transferred it to the ribosomal in the cytoplasm where proteins are synthesized. It attracts itself to ribosome with the sequence specified by mRNA & finally it transmits its amino acid to new polypeptide chain.
8. Frameshift mutation is a type of mutation where addition or deletion of one or two bases changes the reading from the site of mutation, resulting in protein with different set of amino acid.

### ➤ Long Answer:

1. Messenger RNA (mRNA).

It forms only 5% of total RNA but is the longest of all. It brings instructions from DNA for the formation of a particular polypeptide. The instructions are coded in the form of a base sequence called genetic code. Three adjacent nitrogen bases specify a particular amino acid. The formation of polypeptides occurs over the ribosomes. mRNA gets attached to ribosomes.

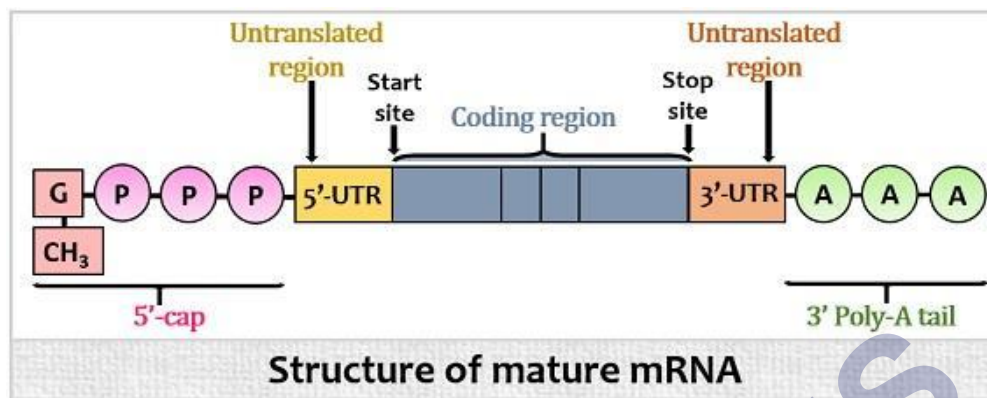

### mRNA.

It starts as a cap for attachment with the ribosome. It is followed by an initiation codon (AUG) either immediately or after a small non-coding region. It is followed by the coding region followed by the termination codon (UAA, UAG, and UGA). Then there is a small non-coding region and poly-A area at 3' termini. The mRNA may specify only a single polypeptide or a number of them called monocistronic and polycistronic respectively.

The life span of mRNA maybe a few minutes to an hour or even days in the case of RBC.

2. The code language of DNA and mRNA is complementary. So, genetic code is the sequence of nucleotides in DNA and RNA that determines the amino acid sequence in proteins. Some amino acids are specified by more than one codon. The sequence of nucleotide on the tRNA molecule which complements the codon is called anticodon, e.g. one of the codons for the amino acid leucine is CUG and the anticodon is GAC. Similarly, the codon for phenylalanine is UUU, while the anticodon is AAA.

Properties of genetic code:

The following properties of genetic code have now been proved by experimental evidence.

- i. The code is a triplet.
- ii. The code is degenerate.
- iii. The code is non-overlapping.
- iv. The code is commaless.
- v. The code is non-ambiguous.
- vi. The code is universal,
- vii. Collinearity.

Both polypeptide and DNA or mRNA have a linear arrangement of their components.

The term code letter stands for a nucleotide A, T, G, or C in DNA and A, U, G, or C in RNA. The sequence of three does not code for any amino acid, such codons are called a non-sense codon, e.g. UGA.

3. Role of ribosomes: Ribosomes usually form linear or helical groups during active protein synthesis



called polyribosomes or polysomes. The mRNA strand having coded information joins along with smaller subunits of ribosomes. The adjacent ribosomes are 360 Å apart.

The different parts of the ribosome connected with protein synthesis are:

- i. A tunnel for mRNA.
- ii. A groove for the passage of newly synthesized polypeptide (larger subunit).
- iii. Two active sites (P-site-peptidyl transfer or donor site and A-site or aminoacyl or acceptor site).
- iv. A binding site for tRNA near A-site.
- v. Presence of enzyme peptidyl transferase.
- vi. Recognition point of smaller subunit for mRNA.
- vii. Presence of GTP-ase, binding sites for elongation factors, and translocases.

### ➤ Assertion and Reason Answers:

1. (a) Both assertion and reason are true, and reason is the correct explanation of assertion.

#### Explanation:

Regulator gene controls the operator gene in cooperation with a chemical compound called inducer present in the cytoplasm. The regulation gene codes for and produce a protein substance called repressor. The repressor substance combines with the operator gene to repress its function. Therefore it is called regulator gene. The constitutive genes keep on functioning all the time. They need not be repressed. Therefore, the regulator and operator genes are not associated with them.

2. (a) Both assertion and reason are false

#### Explanation:

Lactose is not a promoter gene but an inducer of lac operon as it combines with repressor protein formed by repressor or regulatory gene and not the gene itself. The inducer joins the repressor, forming a repressor-inducer complex. This complex prevents the repressor from binding with the operator gene of the operon. This frees the operator gene so that the RNA polymerase can move from the promoter to the structural genes. The structural genes are then transcribed, forming a piece of polycistronic mRNA. The latter is transcribed by tRNA and ribosomes into enzymes.

### ➤ Case Study Answers:

1.

- (i) (b) tRNA

#### Explanation:

tRNA is also referred to as soluble RNA (sRNA) because it cannot be easily separated even by ultra centrifugation technique.

(ii) (d) tRNA

**Explanation:**

tRNA carries specific type of amino acid at CCA end to the ribosome during protein synthesis. It places the required amino acid properly in the sequence and translates the coded message of mRNA in terms of amino acids

(iii) (c) Sugar-phosphate chain

**Explanation:**

The double helix structure is only found in DNA. Ribose is only found in mRNA, DNA has deoxyribose sugar instead. Thymine is found only in DNA, uracil replaces thymine in mRNA. Only the sugar-phosphate backbone is found common in both

(iv) (a) Messenger RN As carries coded information for synthesis of polypeptide.

**Explanation:**

Ribosomal RNA is made in the nucleus. Ribosomal RNA binds with proteins to form large and small ribosomal subunits which combine to form ribosomes in the cytoplasm. Genomic RNA may be single stranded or double stranded. It is fragmented in influenza virus. Synthesis of rRNA occur in nucleolus.

(v) (b) I and II only

**Explanation:**

Uracil is present in this virus. So, RNA is the genetic material. The genetic material is not double stranded as the percentage of guanine and cytosine are not equal. Bases do not pair in single stranded viruses.

2.

(i) (d) Both (a) and (b).

(ii) (d) All of these

**Explanation:**

For DNA fingerprinting, DNA is obtained from blood, semen, hair roots, tissue samples, nuclei of white blood cells or of spermatozoa, body secretions, etc.

(iii) (a) Hybridise with DNA sample to form double stranded structure

**Explanation:**

In DNA fingerprinting, during hybridisation the bands are flooded with single stranded radioactive DNA probe. This single stranded DNA probe and sample DNA hybridise to form double stranded structure due to natural affinity.

(iv) (a) Dr. Lalji Singh

**Explanation:**

In India, DNA fingerprinting technique was developed by Dr. Lalji Singh.

(v) (d) All of these

SHIVOM CLASSES  
8696608541